

# Compact, Multi-function, Multiple Instructions PLC Instruction Sheet

## DVP-SA

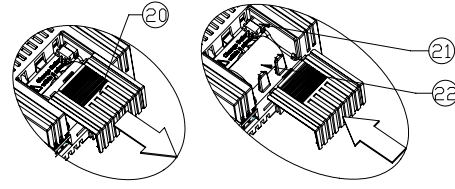

- 14 DIN rail (35mm)
- 15 Extension unit clip
- 16 COM2 (RS-485) Communication port
- 17 DC Power input
- 18 2 pin removable terminal (standard accessory)
- 19 Power input cable (standard accessory)
- 20 Battery Cover
- 21 Battery socket connection
- 22 Battery mount

### 1 WARNING

This Instruction Sheet only provides descriptions for electrical specifications, general specifications, installation & wiring, troubleshooting and peripherals. Other detail information about programming and instructions is compatible with SA/SX/SC series; please see PLC Application Manual. For more information about the optional peripherals, please see individual product manual.

This is an OPEN TYPE PLC. The PLC should be kept in an enclosure away from airborne dust, humidity, electric shock risk and vibration. Also, it is equipped with protective methods such as some special tools or keys to open the enclosure, in order to prevent hazard to users or damage the PLC.

Do NOT connect the AC main circuit power supply to any of the input/output terminals, or it may damage the PLC. Check all the wiring prior to power up. To prevent any electromagnetic noise, make sure the PLC is properly grounded. Do NOT touch terminals when power on.

### 2 INTRODUCTION

#### 2.1 Model Name Explanation and Peripherals

Thank you for choosing DELTA's PLC DVP series. The DVP-SA series has a 12-points (8 input points + 4 outputs) PLC main processing unit with multiple instructions for use. It also has an 8K Steps program memory to connect to every SA/SX/SC series extension unit, including digital I/O (Maximum 128 Input / 128 Output extension points), analog module, etc. for various applications. Its power unit is separated from the MPU for better space utilization and easier installation.

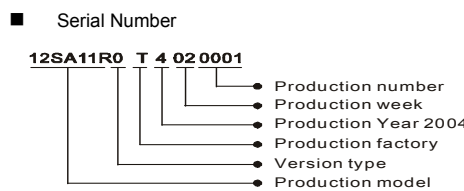
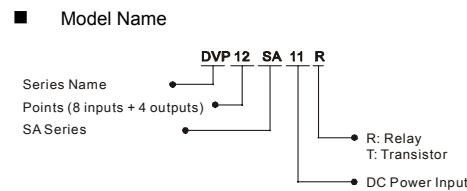
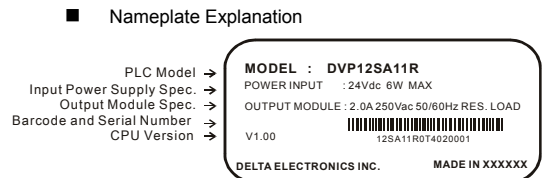

- Peripherals
- ◎ DVPHP02: Handheld Programming panel
- ◎ WPLSoft: Windows Ladder Logic Programming Software
- ◎ DVPACAB115: 1.5M Cable (HPP ↔ PLC, included in DVPHP02)
- ◎ DVPACAB215: 1.5M Cable (PC (DB9+DB25) ↔ PLC)
- ◎ DVPACAB230: 3.0M Cable (PC (DB9+DB25) ↔ PLC)
- ◎ DVPACAB2A30: 3.0M Cable (PC (DB9) ↔ PLC)

#### 2.2 Product Profile and Outline

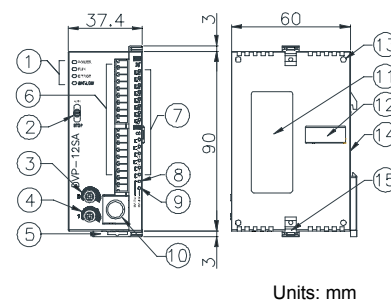

※ Battery replacement: Battery replacement must be finished within 3 minutes, or the internal data of the PLC (including the program area, RTC and latched registers) could be lost or destroyed.

- 1 Status indicator: POWER, RUN, ERROR, BAT.LOW
- 2 RUN/STOP switch
- 3 VR0: Start-up by M1178/D1178 Corresponding value
- 4 VR1: Start-up by M1179/D1179 corresponding value
- 5 DIN rail clip
- 6 I/O terminals
- 7 I/O point indicators
- 8 COM1 (RS-232) (Rx) indicator
- 9 COM2 (RS-485) (Tx) indicator
- 10 COM1 (RS-232) port
- 11 Nameplate
- 12 Extension port
- 13 Mounting hold of the extension unit

### 3 FUNCTION SPECIFICATIONS

Items	Specifications	Remarks	
Control Method	Stored program, cyclic scan system		
I/O Processing Method	Batch processing method (when END instruction is executed)	I/O refresh instruction is available	
Execution Speed	Basic instructions (several us)	Application Instructions (10~hundreds us)	
Program language	Instructions + Ladder Logic + SFC	Including the Step instructions	
Program Capacity	7920 STEPS	SRAM + Battery	
Instructions	32 Basic sequential instructions (including STL/RET)	168 Application instructions	
X External input relay	X0~X177 in octal, 256 points in decimal	Total 256 points	
	Y External output relay	Y0~Y177 in octal, 256 points in decimal	Correspond to external output point
M Auxiliary Relay	General	M0~M511, 512 points (*1)	Total 4096 points
	Latched	M512~M999, 488 points (*3)	
		M2000~M4095, 2096 points (*3)	
	Special	M1000~M1999, 1000 points (some are latched)	
T Timer	100ms	T0~T199, 200 points (*1) T192~T199 for Subroutine T250~T255, 6 points Accumulative (*4)	Total 256 points
	10ms	T200~T239, 40 points (*2)	
		T240~T245, 6 points Accumulative (*4)	
	1ms	T246~T249, 4 points Accumulative (*4)	
C Counter	16-bit count up	C0~C95, 96 points (*1)	Total 250 points
		C96~C199, 104 points (*3)	
	32-bit count up/down	C200~C215, 16 points (*1)	
		C216~C234, 19 points (*3)	
	32bit high-speed count up/down	C235~C245, 1 phase 1 input, 9 points (*3) C246~C250, 1 phase 2 input, 3 points (*3) C251~C254, 2 phase 2 input, 3 points (*3)	
S Step point	Initial step point	S0~S9, 10 points (*1)	Total 1024 points
	Zero point return	S10~S19, 10 points (use with IST instruction) (*1)	
	General	S20~S511, 492 points (*1)	
	Latched	S512~S895, 384 points (*3)	
	Alarm	S896~S1023, 124 points (*3)	
T Current value of the timer	T0~T255, 256 points	When the timer reaches the preset value, the contact of timer will be On.	
C Current value of the counter	C0~C199, 16-bit counter, 200 points C200~C254, 32-bit counter, 50 points	When the counter reaches the preset value, the contact of counter will be On.	
D Data register	General	D0~D199, 200 points (*1)	Total 5000 points
	Latched	D200~D999, 800 points (*3)	
	Special	D1000~D1999, 1000 points	
None	Index	E0~E3, F0~F3, 8 points (*1)	
	File register	0~1599 (1600 points) (*4)	Extension register to store data.
N For master control nested loop	N0~N7, 8 points	Control point of master control nested loop	
P For CJ, CALL instructions	P0~P255, 256 points	The location point of CJ, CALL.	
I Interrupt Service	External interrupt	I001 (X0), I101 (X1), I201 (X2), I301 (X3), I401 (X4), I501 (X5); 6 points (all are rising-edge trigger)	The location pointer of interrupt subroutine
	Time interrupt	I6□□ (1ms), I7□□ (1ms), (□□ = 1~99ms)	
	High-speed counter	I010, I020, I030, I040, I050, I060; 6 points	
	Communication	I150, 1 point	
K Decimal		K-32,768 ~ K32,767 (16-bit operation) K-2,147,483,648 ~ K2,147,483,647 (32-bit operation)	
	H Hexadecimal	H0000 ~ HFFFF (16-bit operation), H00000000 ~ HFFFFFFF (32-bit operation)	
Programming port	COM1: RS-232, COM2: RS-485 (Master/Slave), They can be used at the same time.		
Potentiometer / Perpetual Calendar (RTC)	MPU built-in 2 points VR / MPU built-in RTC		
Special Extension Module	Use the same modules (AD, DA, PT, TC, XA, RT) of SS series. (Max. 8 Extension Unit points)		

- \*1: The non-latched area is fixed, and can't be changed.
- \*2: The non-latched area can be changed to a latched area with parameter setting.
- \*3: The latched area can be changed to a non-latched area with parameter setting.
- \*4: The latched area is fixed, and can't be changed.

M Auxiliary Relay	General	Latched	Special auxiliary relay	Latched
	M0~M511	M512~M999	M1000~M1999	M2000~M4095
Non-latched (fixed)	Latched (default) Start: D1200 (K512) End: D1201 (K999)	Some are latched and can't be changed	Latched (default) Start: D1202 (K2000) End: D1203 (K4095)	
T Timer	100 ms	10 ms	10ms	1 ms
	T0~T199	T200~T239	T240~T245	T246~T249
	Non-latched (fixed)	Non-latched (fixed)	Accumulative Latched (fixed)	
C Counter	16-bit count up		32-bit count up/down	
	C0~C95	C96~C199	C200~C215	C216~C234
Non-latched (fixed)	Latched (default) Start: D1208 (K96) End: D1209 (K199)	Non-latched (fixed)	Latched (default) Start: D1210 (K216) End: D1211 (K234)	Latched (default) Start: D1212 (K235) End: D1213 (K255)
S Step relay	For general	Latched	Special register	Latched
	S0~S9	S10~S19	S20~S511	S512~S895
	It is fixed to be non-latched		Factory setting is latched Start: D1214 (K512) End: D1215 (K895)	It is fixed to be latched
D Register	General	Latched	Special registers	Latched
	D0~D199	D200~D999	D1000~D1999	D2000~D4999
Non-latched (fixed)	Factory setting is latched. Start: D1216 (K200) End: D1217 (K999)	Some are latched and can't be changed.	Factory setting is latched. Start: D1218 (K2000) End: D1219 (K4999)	
File Register	K0~K1599 Latched (fixed)			

※ When switching between power On/Off or MPU RUN/STOP modes:

Memory Type	POWER Off→On	STOP→RUN	RUN→STOP	Clear all M1031 non-latched area	Clear all M1032 latched area	Factory Setting
Non-latched	Clear	Unchanged	M1033=Off, clear M1033=On, unchanged	Clear	Unchanged	0
Latched	Unchanged			Unchanged	Clear	0
Special M, Special D, Index register	Initial value	Unchanged		Unchanged		Initial value
File register	Unchanged					

### 4 ELECTRICAL SPECIFICATIONS

Item	Model	DVP12SA11R/T	DVP08SM11N	DVP08SN11R/T	DVP08SP11R/T	DVP16SP11R/T
Power supply voltage	MPU: 24VDC (-15%~20%) (With DC input reverse polarity protection), Extension Unit: supplied by the MPU					
Fuse	2A / 250VAC					
Power Consumption	3.5W	1W	1.5W	1.5W	2W	
Insulation Resistance	> 5 MΩ at 500 VDC (Between all inputs / outputs and earth)					
Noise Immunity	ESD: 8KV Air Discharge EFT: Power Line: 2KV, Digital I/O: 1KV, Analog & Communication I/O: 250V Damped-Oscillator Wave: Power Line: 1KV, Digital I/O: 1KV RS: 26MHz~1GHz, 10V/m					
Grounding	The diameter of grounding wire cannot be smaller than the wire diameter of terminals L and N (All DVP units should be grounded directly to the ground pole).					
Environment	Operation: 0°C~55°C (Temperature), 50~95% (Humidity), Pollution degree 2; Storage: -25°C~70°C (Temperature), 5~95% (Humidity)					
Vibration / Shock Resistance	Standard: IEC1131-2, IEC 68-2-6 (TEST Fc) / IEC1131-2 & IEC 68-2-27 (TEST Ea)					
Weight (approx.) (g)	158	128	154 / 146	141 / 136	162 / 154	
Approvals						

Input Point Electrical Specification		Output Point Electrical Specification		
Input Type	DC (SINK or SOURCE)	Output Type	Relay-R	Transistor-T
Input Current	24VDC 5mA	Current Specification	1.5A/1 point (5A/COM)	0.3A/1 point @ 40°C; When the output of Y0 and Y1 is high-speed pulse, Y0 and Y1 = 30mA
Active Level	Off→On, above16VDC	Voltage Specification	Below 250VAC, 30VDC	30VDC
	On→Off, below 14.4VDC		75VA (Inductive) 90 W (Resistive)	9W/1 point
Response Time	About 10ms (An adjustment range of 0~20ms could be selected through D1020 and D1021)	Response Time	About 10 ms	Off→On 20us On→Off 30us Y0 and Y1 are specified points for high-speed pulse

**5 MODEL NAME & I/O CONFIGURATION**

Standard MPU

Model	Power	Input / Output		Profile reference	I/O Configuration
		Point	Type		
DVP12SA11R	24VDC	8	DC Sink or Source		S/S X0 X1 X2 X3 X4 X5 X6 X7 C0 Y0 C1 Y1 Y2 Y3 •
DVP12SA11T		8			4
					Transistor

**6 INSTALLATION & WIRING**

**6.1 PLC Mounting Arrangements and Wiring Notes**

Installation of the DIN rail

The DVP-PLC can be secured to a cabinet by using the DIN rail that is 35mm high with a depth of 7.5mm. When mounting the PLC on the DIN rail, be sure to use the end bracket to stop any side-to-side motion of the PLC, thus to reduce the chance of the wires being pulled loose. At the bottom of the PLC is a small retaining clip. To secure the PLC to the DIN rail, place it onto the rail and gently push up the clip. To remove it, pull down the retaining clip and gently pull the PLC away from the DIN rail. As shown on the right:

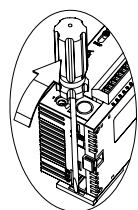

When installing the DVP series PLC, make sure that it is installed in an enclosure with sufficient space (as shown below) to its surroundings so as to allow heat dissipation.

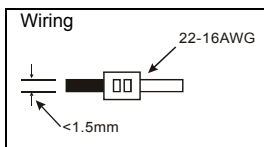
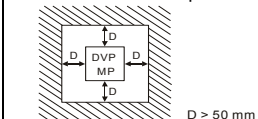

- Notes:
- Please use 22-16AWG (1.5mm) wiring (either single or multiple core) for I/O wiring terminals. The specification for the terminals is as shown on the left. PLC terminal screws should be tightened to between 1.95 kg-cm (1.7 in-lbs).
  - I/O signal wires or power supply should not run through the same multi-wire cable or conduit. Use Copper Conductor Only, 60/75 °C.

**6.2 Wiring Notes**

Environment

- DO NOT store the PLC in an atmosphere that is dusty, smoky, with metallic debris or corrosive or flammable gases.
- DO NOT store the PLC in an environment with high temperature or high humidity.
- DO NOT install the PLC on a shelf or on an unstable surface.

Power Input Wiring

DVP-SA series input power supply is DC input. Please take a note of listed items when operating DVP-SA Series.

- Please make sure the power is at terminals 24VDC and 0V (power range is 20.4VDC~28.8VDC). When voltage is lower than 20.4VDC, PLC will stop operating, all outputs will be Off and ERROR LED will flash continuously.
- If the power-cut time is less than 10ms, the PLC still operates unaffectedly. If the power-cut time is too long or the power voltage drops, the PLC will stop operating and all the outputs will be Off. Once the power is restored, the PLC will return to operation automatically. (There are latched auxiliary relays and registers inside of the PLC, please be aware when programming.)

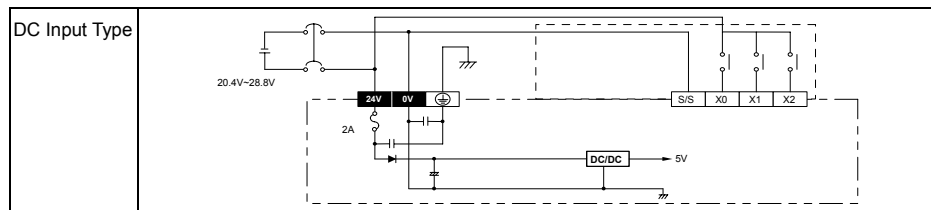

Safety Wiring

Since the PLC is used to control numerous devices, motion of either one device could affect the motion of other devices. Therefore the breakdown of a device would consequently be detrimental to the whole auto control system, thus the result is dangerous. Please use the recommended wiring below for the power input:

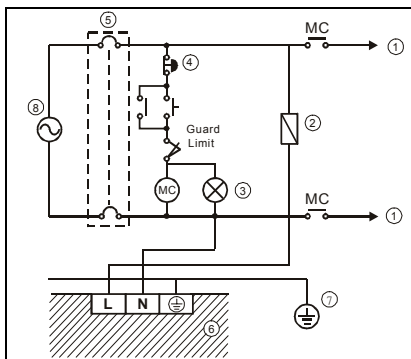

- Power supply for AC loads
- Power Circuit Protection Fuse (3A)
- Power On pilot indicator
- Emergency stop  
The machinery must provide a quick manual method disconnecting all system power.
- Circuit isolation device (System Power Disconnect)  
Utilize the electromagnetic contactor and the relay to be the isolation unit of the power circuit to prevent the possible instability of the system when the power is supplied on and off.
- DVP PLC MPU (main processing unit)
- Grounding
- Power supply:  
AC: 100~240VAC, 50/60Hz  
DC: 24VDC

Input Point Wiring

The DC power is used for DC input signal.

Two types of DC wiring are used: SINK and SOURCE, defined as follows:

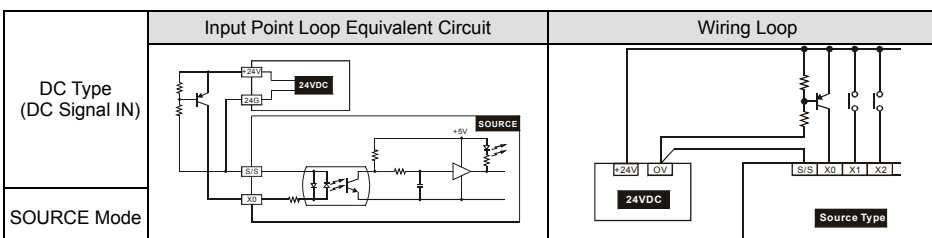
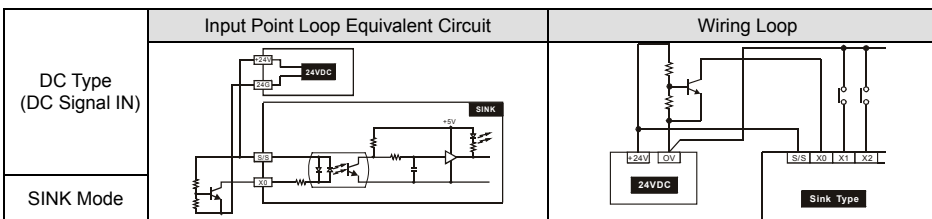
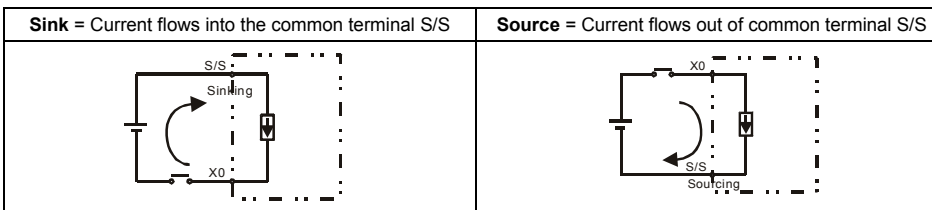

Output Point Wiring

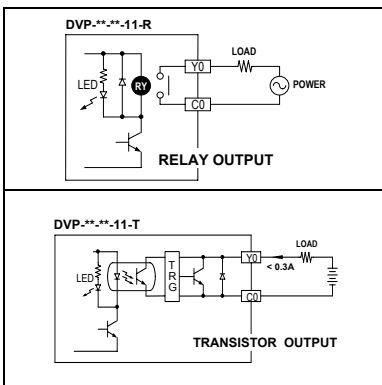

- Two types of DVP-SA Series PLC output modules: Relay or Transistor. For the electrical specification, please refer to the function specification.
- Please watch out the connection of common terminals while wire the outputs. For example, when wiring DVP12SA11R, output terminal Y0 uses one common terminal C0, Y1 uses C1, and Y2~Y3 share C2, as shown below:

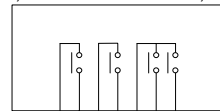

- Isolated circuit: The optical coupler is used to isolate signals between PLC internal circuits and input modules.

**7 TRIAL RUN**

Power Indicator

The "POWER" LED at the front of the MPU or the Extension Units will be lit (in green) if the power is on. If the indicator is not ON or ERROR LED is blinking swiftly when the MPU is powered up, it means that the +24V power supply of the PLC is insufficient, i.e. the 24V DC power supply of the PLC is overloaded. It is thus necessary to remove the wiring on terminals +24V and 24G, and to use a 24VDC power supply instead.

Low Voltage Indicator

The "LOW V." LED on the Extension Unit is an indication that the input power voltage is insufficient, thus all outputs of the extension unit should be turned off.

Low Battery Voltage Indicator

There is also a "BAT.LOW" LED at the front of the MPU. When the LED is on, it indicates that the battery voltage is not enough. Please change the battery (within 3 minutes) as soon as possible; otherwise the user programs and the data in latched area may be lost.

Preparation

- Prior to applying power, please verify that the power lines and the input/output wiring are correct. And be advised not to supply AC110V or AC220V into the I/O terminals, or it might short-circuit the wiring and would cause direct damage to the PLC.
- After using the peripheral devices to write the program into the MPU and that the ERROR LED of the MPU is not on, it means that the program in use is legitimate, and it is now waiting for the user to give the RUN instruction.
- Use HPP to execute the forced On/Off test of the output contact.

Operation & Test

If the "ERROR" LED of the MPU is not blinking, use RUN/STOP switch or the peripheral devices (HPP or WPLSoft) to give the RUN instruction, and the RUN indicator will then be on. If the "RUN" LED is not on, it indicates that there is no program inside the PLC.

HPP could be utilized to monitor the settings and the registered values of the timer (T), the counter (C) and the data register (D) during operation. If the ERROR LED is on (but not blinking), it means that the setting of the user's program has exceeded the preset time-out limit. At this case, please turn the PLC RUN/STOP switch to STOP, and find out the address of the time-out program by special data register D1008. "WDT" instruction can be used to solve the problem.

PLC Input/Output Response Time

The total response time from the input signal to the output operation is calculated as follows:  
Reaction Time = input delay time + program scan time + output delay time

Input delay time	Factory setting: 10 ms. Please refer to the usage of special registers D1020~1021.
Program scan time	Please refer to special register D1010 for detail.
Output delay time	Relay module: 10ms. Transistor module: 20~30us.

Basic Instructions and Application Instructions of the PLC:

- The basic instructions and the application instructions of the MPU of this series are totally applicable to the DELTA DVP-PLC SA/SX/SC Series MPU. Refer to the DELTA PLC Technique Application Manual for relevant basic instructions and application instructions.
- All Delta DVP-PLC series can use DVPHPP handheld programming panel and the WPLSoft (Windows version) to edit program. Also, the PLC could connect with the DVP12SA MPU through specific transmission wire to execute the program transmission, the MPU control and the program monitoring.

**8 TROUBLESHOOTING**

Judge the errors by the indicators on the front panel. When errors occurred on DVP PLC, please check:

"POWER" LED

There is a "POWER" LED at the front of the MPU. When the MPU is powered On, the green LED light will be on. If the indicator is not on when the MPU is powered up and with the input power being normal, it is an indication that the PLC is out of order. Please have this machine replaced or contact the dealer near you for repair.

PLC "RUN" LED

Identify the status of the PLC. When the PLC is in operation, this light will be on, and users could thus use HPP or the editing program of the ladder diagram to give instructions to make the PLC "RUN" or "STOP".

"ERROR" LED

If incorrect programs are loaded to the MPU, or that the instructions and the components exceed the allowable range, the indicator will blink. At this moment, the user should check both the error codes saved in the MPU data register D1004 and the Error Code Table below to correct the programs. The address that the error occurs will be saved to data register D1137 (the address saved in D1137 is invalid in case of common loop error). When the ERROR LED is on (not blinking), users should make a judgment from the special relay M1008 of the MPU. If it is On, it indicates that the execution time of the program loop has exceeded the time-out setting (set by D1000). Please turn the PLC RUN/STOP switch to STOP, and find out the address of the time-out program by special data register D1008. "WDT" instruction can be used to solve the problem. Once program modification is completed, user can re-download the program of PLC and the ERROR LED will be off. If the ERROR LED is still keep on, please turn off the power and check if there's any noise or any conductive invader inside the PLC.

"BAT.LOW" LED

When the battery voltage is low, the "BAT.LOW" LED will be on, and the battery should be replaced as soon as possible; otherwise the user program and the data in latched area will lose. (For the unplugged PLC, please change the battery within 3 minutes to retain the PLC's internal user programs and data). Choose lithium battery TDRTL-2150/S. Please refer to the following table for battery life information.

Battery life :

Temperature(°C)	0	25	50	70
Life(Years)	9	8	6	5

Precision of calendar timer :

- At 0°C/32°F, less than -117 seconds error per month.
- At 25°C/77°F, less than 52 seconds error per month.
- At 55°C/131°F, less than -132 seconds error per month.

"Input" LED

The On/Off signals of the input point could be displayed through the "Input" LED, or the status of the input point could be monitored through the device monitoring function of HPP.

"Output" LED

Output LED indicates if the output signals are On or Off. Please check the items below when the LED On/Off indication does not correspond to the instructions: 1. Output contacts may be melted and stuck together due to a short circuit or current overload. 2. Check wiring and verify that the screws are tight.

Error Code (D1004, Hexadecimal Number) Table

Code	Explanation	Code	Explanation	Code	Explanation
0001	Device S exceeds the usage limit	0E04	C register exceeds the usage limit	C404	FOR-NEXT exceeds 6 levels
0002	Misused Label P	0E05	Misused operand CXXX of DCNT	C405	Misused STL/RET
0003	KnSm exceeds the usage limit	0E0F	Index registers E and F exceed the usage limit		Misused SRET/IRET
0102	Misused Label I	0E18	BCD conversion error		Misused MC/MCR
0202	Misused MC	0E19	Division Error (divisor=0)		Misused END/FEND
0302	Misused MCR	0E1A	Component exceeds the usage limit (including E and F error)	C407	STL has been used for more than 9 times consecutively
0401	Device X exceeds the usage limit	0E1B	The root is negative	C408	MC/MCR used within STL
0403	KnXm exceeds the usage limit	0E1C	FROM/TO communication error		I/P used within STL
0501	Device Y exceeds the usage limit	0F04	D register exceeds the usage limit	C409	STL/RET used within Subroutine
0503	KnYm exceeds the usage limit	0F05	Misused operand DXXXX of DCNT		STL/RET used within the Interrupt Service Routine
0601	Device T exceeds the usage limit	0F06	Misused SFTR operands	C40A	Misused MC/MCR (Subroutine)
0604	T register exceeds the usage limit	0F07	Misused SFTL operands		Misused MC/MCR (ISR)
0801	Device M exceeds the usage limit	0F08	Misused REF operands	C40B	MC/MCR does not begin from N0 nor of continuous status
0803	KnMm exceeds the usage limit	0F09	Misused WSFR, WSFL operands	C40C	Misused MC/MCR
0D01	Misused DECO operands	0F0A	Misused TTMR, STMR instructions		Use I/P incorrectly
0D02	Misused ENCO operands	0F0B	SORT instruction exceeds the usage times limit	C40E	IRET does not go after the last FEND instruction
0D03	Misused DHSCS operands	0F0C	TKY instruction exceeds the usage times limit		SRET does not go after the last FEND instruction
0D04	Misused DHSCR operands	0F0D	HKY instruction exceeds the usage time limit	C41C	I/O points of the extension unit exceed the limit
0D05	Misused PLSY operands	1000	Misused ZRST operands	C41D	Special extension module exceeds the limit
0D06	Misused PWM operands	C400	Illegitimate instructions	C41E	Error setting of Ext. module
0D07	Misused FROM/TO operands	C401	Loop error	C41F	Data write in memory failure
0D08	Misused PID operands	C402	Misused LD /LDI instructions	C4FF	Invalid instruction
0D09	Misused DHSZ operands	C403	Misused MPS instructions	C4EE	Missing END statement
0E01	Device C exceeds the usage limit				